



CrownWall[®]
Catalog 2024

Discover who we are

Why CrownWall®

1-3

Slatwall Panels

4-11

Accessories

12-29

Accessory Kits

30-36

Overhead Storage

37-41

PRO Series Cabinets

42-49

ZOOMflor™ Flooring

50-54



Why

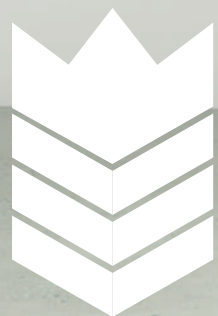

Crown Wall[®] ?



Mission

CrownWall® is a proud North American manufacturer of premium products that set the standard for excellence in the garage industry today. From slatwall panels, slatwall accessories, storage cabinets, and flooring. We deliver products to enhance any type and size of garage.

Our mission is to develop and manufacture the best interior solutions available for not only the garage, but any other part of the home.

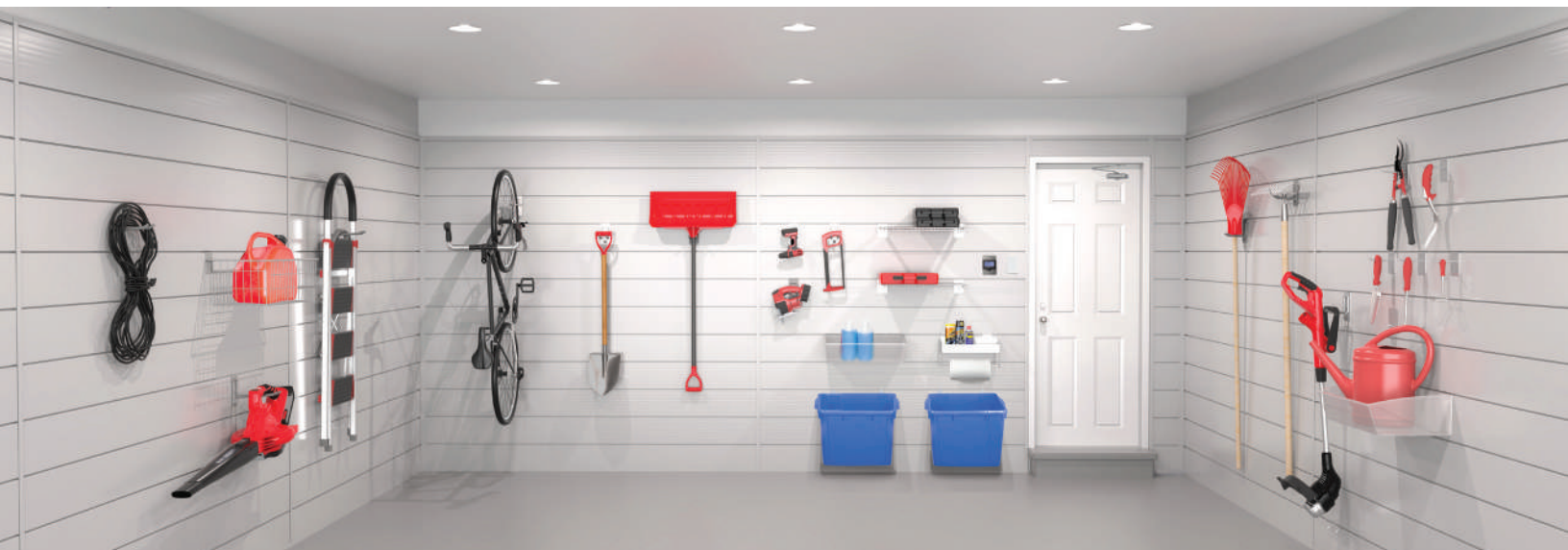

Capabilities

Slatwall panels made exclusively in North America, enables us to:

- Deliver product with short lead times
- Always have product in stock
- Largest PVC panel extruder in North America, guaranteeing material security for production



Benefits



**Fast
Delivery**



**Discount
Structure**



**Vendor
Portal**



**Always Available
Stock**



**CSR
SUPPORT**



**3D
VISUALIZER**



Slatwall Panels

The CrownWall® System

CrownWall® is our brand of PVC slatwall, the core of our business. Our unique patented system works by having each individual slatwall panel connect to each other. We are the only company to offer a wide range of different sized panels that are all compatible with each other. All of which allow for a wide range of benefits.



Strongest

- Strongest slatwall panels on the market



Light Weight

- Conveniently packed in a box
- Can be transported with most vehicles
- Easy to handle



Moisture Resistant

- Moisture resistant
- Mold resistant



Temperature Resistant

- Can withstand extreme temperatures
- Flame resistant



Strong Construction

- Full back eliminates warping
- Impact resistant

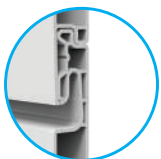

Easy and Secure Assembly

- Patented locking feature ensures level installation
- Hidden fasteners allow for a clean and continuous look when assembled

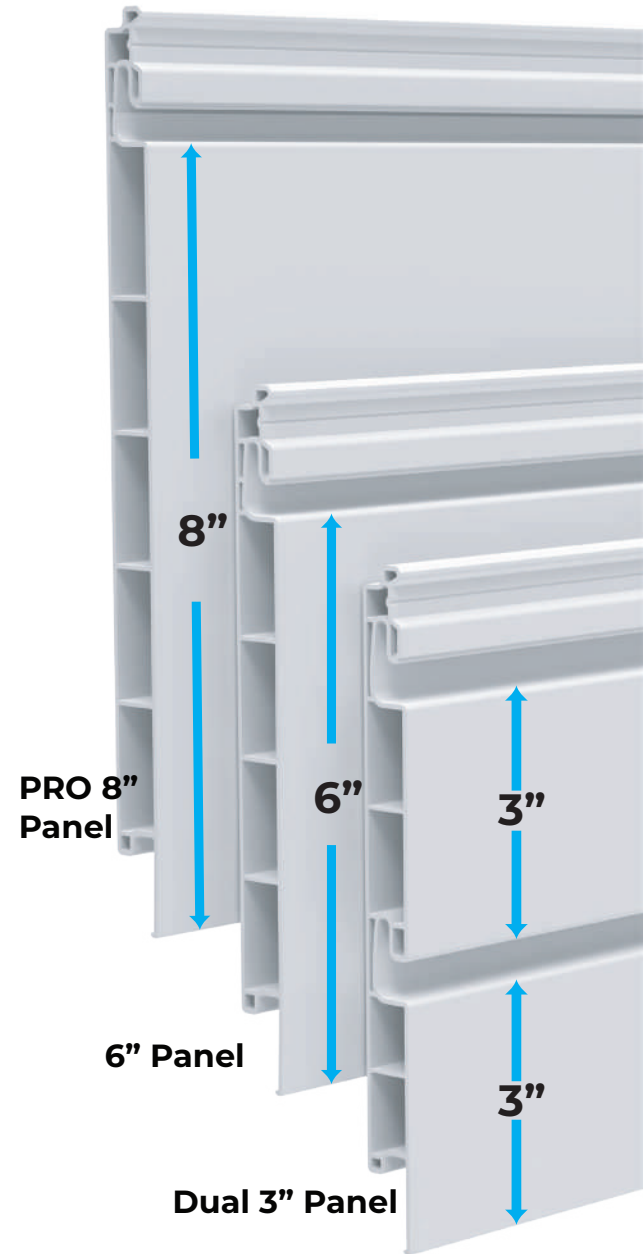

CrownWall® 6" - 4' x 4' Panel Kit

The versatile 6" - 4' x 4' Panel kit is the easiest solution for organizing both small and large spaces. The kit includes all necessary components and is ready to install out of the box. When installed this panel will hold **150 lb/sq. ft.**

Included in the Kit

- 8 x CrownWall® 6" Panels (48")
- 1 x Top Trim (48")
- 2 x J-Trim (48")
- 35 Screws
- 1 Screw Bit
- Trilingual Instruction Manual

Panel Kit Available Colors:

	Graphite CW644GRA-K		Dove Grey CW644DVG-K
	White CW644WHT-K		Sandstone CW644SAN-K

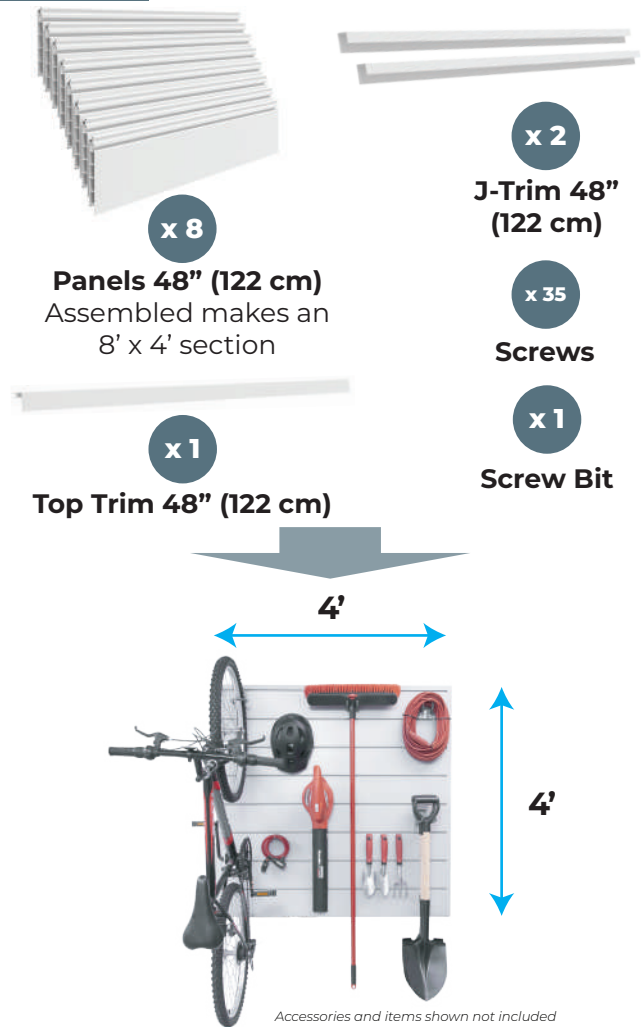

SKU Overview

Product	Color	SKU	Box Length	Box Width	Box Height	Panels /Box	Kit Weight	Coverage/Kit
PVC Panels	Graphite	CW644GRA-K	48"	8.5"	5"	8	18 lbs/8.2 kg	16 sq.ft.
PVC Panels	Dove Grey	CW644DVG-K	48"	8.5"	5"	8	18 lbs/8.2 kg	16 sq.ft.
PVC Panels	White	CW644WHT-K	48"	8.5"	5"	8	18 lbs/8.2 kg	16 sq.ft.
PVC Panels	Sandstone	CW644SAN-K	48"	8.5"	5"	8	18 lbs/8.2 kg	16 sq.ft.

Pallet Overview

Product	Color	SKU	Kits / Pallet	Pallet Dims. (LxWxH)	Pallet Weight
PVC Panels	Graphite	CW644GRA-K	40	48" x 40" x 45"	760 lbs/344kg
PVC Panels	Dove Grey	CW644DVG-K	40	48" x 40" x 45"	760 lbs/344kg
PVC Panels	White	CW644WHT-K	40	48" x 40" x 45"	760 lbs/344kg
PVC Panels	Sandstone	CW644SAN-K	40	48" x 40" x 45"	760 lbs/344kg

CrownWall® 6" - 8' x 4' Panel Kit

The CrownWall® 6" panel is offered in a convenient 8' x 4' panel kit. A great solution for organizing larger spaces. The kit includes all necessary components and is ready to install out of the box. When installed this panel kit will hold **150 lb/sq. ft.**

Included in the Kit

- 8 x CrownWall® 6" Panels (96")
- 1 x Top Trim (96")
- 2 x J-Trim (48")
- 60 Screws
- 1 Screw Bit
- Trilingual Instruction Manual

Panel Kit Available Colors

	Graphite CW684GRA-K		Dove Grey CW684DVG-K
	White CW684WHT-K		Sandstone CW684SAN-K

SKU Overview

Product	Color	SKU	Box Length	Box Width	Box Height	Panels /Box	Kit Weight	Coverage/Kit
PVC Panels	Graphite	CW684GRA-K	96"	8.5"	5"	8	38 lbs/17.2 kg	32 sq.ft.
PVC Panels	Dove Grey	CW684DVG-K	96"	8.5"	5"	8	38 lbs/17.2 kg	32 sq.ft.
PVC Panels	White	CW684WHT-K	96"	8.5"	5"	8	38 lbs/17.2 kg	32 sq.ft.
PVC Panels	Sandstone	CW684SAN-K	96"	8.5"	5"	8	38 lbs/17.2 kg	32 sq.ft.

Pallet Overview

Product	Color	SKU	Kits / Pallet	Pallet Dims. (LxWxH)	Pallet Weight
PVC Panels	Graphite	CW684GRA-K	40	96" x 42" x 45"	1520 lbs/689kg
PVC Panels	Dove Grey	CW684DVG-K	40	96" x 42" x 45"	1520 lbs/689kg
PVC Panels	White	CW684WHT-K	40	96" x 42" x 45"	1520 lbs/689kg
PVC Panels	Sandstone	CW684SAN-K	40	96" x 42" x 45"	1520 lbs/689kg

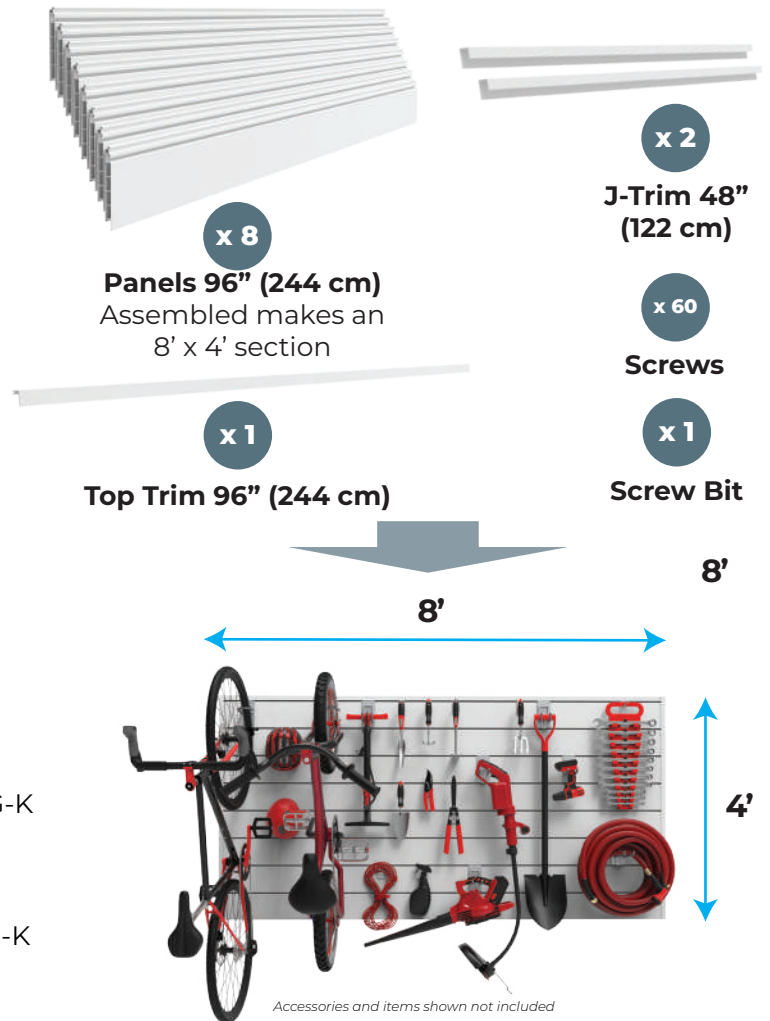

CrownWall® PRO 8" Panel Bundles



The CrownWall® PRO 8" panel is our premium panel. Sold in bulk bundles and ideal for covering any size of garage. Floor to ceiling, banding around the garage, or any custom application. Also great for any room in the house. Such as a games room, pantry, home office, or home gym.

Specifications

- 8" Visible reveal when installed
- Sold in 8 foot lengths, bundles of 6 panels (32 sq. ft.)
- Available also in 10, 12, 14, and 16 foot lengths (with MOQs, call for details)
- Compatible exclusively with CrownWall® Accessories
- Weight capacity of **250 lbs/sq. ft.**
- **Trims sold separately**



Panel Standard Colors and SKUs:

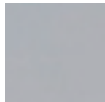

Graphite
CW884GRA-B



Dove Grey
CW884DVG-B

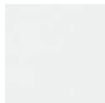

White
CW884WHT-B



Sandstone
CW884SAN-B

Panel Premium Colors and SKUs:

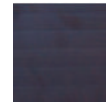

Black
CW884BLK-B



Blue
CW884BLU-B

Panel SKU Overview

Product	Color	SKU	Panel Height	Panel Length	Panel Width	Panels /Bundle	Bundle Weight	Coverage /Bundle
PVC Panels	Graphite	CW884GRA-B	8"	8'	.5"	6	36 lbs/16.3 kg	32 sqft
PVC Panels	Dove Grey	CW884DVG-B	8"	8'	.5"	6	36 lbs/16.3 kg	32 sqft
PVC Panels	White	CW884WHT-B	8"	8'	.5"	6	36 lbs/16.3 kg	32 sqft
PVC Panels	Sandstone	CW884SAN-B	8"	8'	.5"	6	36 lbs/16.3 kg	32 sqft
PVC Panels	Black	CW884BLK-B	8"	8'	.5"	6	36 lbs/16.3 kg	32 sqft
PVC Panels	Blue	CW884BLU-B	8"	8'	.5"	6	36 lbs/16.3 kg	32 sqft

Pallet Overview

Product	Color	SKU	Bundles / Pallet	Pallet Dims. (LxWxH)	Pallet Weight
PVC Panels	Graphite	CW884GRA-B	40	96" x 42" x 43"	1440 lbs/653 kg
PVC Panels	Dove Grey	CW884DVG-B	40	96" x 42" x 43"	1440 lbs/653 kg
PVC Panels	White	CW884WHT-B	40	96" x 42" x 43"	1440 lbs/653 kg
PVC Panels	Sandstone	CW884SAN-B	40	96" x 42" x 43"	1440 lbs/653 kg
PVC Panels	Black	CW884BLK-B	40	96" x 42" x 43"	1440 lbs/653 kg
PVC Panels	Blue	CW884BLU-B	40	96" x 42" x 43"	1440 lbs/653 kg

Dual 3" Panel Bundles

In addition to the CrownWall® PRO 8" slatwall panel, also being offered is the CrownWall® Dual 3" panel. Both panels are compatible with each other, and can be installed together. This panel is perfect for organizing smaller items.

Specifications

- 6" Visible reveal when installed, with two 3" reveals per panel
- Sold in 8 foot lengths, bundles of 8 panels (32 sq. ft.)
- Compatible exclusively with CrownWall® Accessories
- Weight capacity of **150 lbs/per sq. ft.**

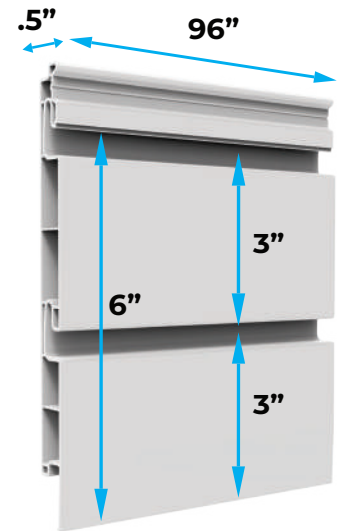

Standard Colors

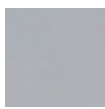

Graphite
CWD384GRA-B



Dove Grey
CWD384DVG-B

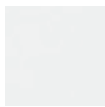

White
CWD384WHT-B



Sandstone
CWD384SAN-B

Premium Colors

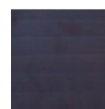

Black
CWD384BLK-B



Blue
CWD384BLU-B

Panel SKU Overview

Product	Color	SKU	Panel Height	Panel Length	Panel Width	Panels /Bundle	Bundle Weight	Coverage /Bundle
PVC Panels	Graphite	CWD384GRA-B	6"	8'	.5"	8	38 lbs/17.2 kg	32 sqft
PVC Panels	Dove Grey	CWD384DVG-B	6"	8'	.5"	8	38 lbs/17.2 kg	32 sqft
PVC Panels	White	CWD384WHT-B	6"	8'	.5"	8	38 lbs/17.2 kg	32 sqft
PVC Panels	Sandstone	CWD384SAN-B	6"	8'	.5"	8	38 lbs/17.2 kg	32 sqft
PVC Panels	Black	CWD384BLK-B	6"	8'	.5"	8	38 lbs/17.2 kg	32 sqft
PVC Panels	Blue	CWD384BLU-B	6"	8'	.5"	8	38 lbs/17.2 kg	32 sqft

Pallet Overview

Product	Color	SKU	Bundles / Pallet	Pallet Dims. (LxWxH)	Pallet Weight
PVC Panels	Graphite	CWD384GRA-B	40	96" x 42" x 45"	1520 lbs/689kg
PVC Panels	Dove Grey	CWD384DVG-B	40	96" x 42" x 45"	1520 lbs/689kg
PVC Panels	White	CWD384WHT-B	40	96" x 42" x 45"	1520 lbs/689kg
PVC Panels	Sandstone	CWD384SAN-B	40	96" x 42" x 45"	1520 lbs/689kg
PVC Panels	Black	CWD384BLK-B	40	96" x 42" x 45"	1520 lbs/689kg
PVC Panels	Blue	CWD384BLU-B	40	96" x 42" x 45"	1520 lbs/689kg

Trims (Compatible with all Panel Sizes)

Top Trim

Top Trim is used to finish the top of wall segments.

Top Trim Standard Colors



Graphite
TOPTRIM8GRA



Dove Grey
TOPTRIM8DVG



White
TOPTRIM8WHT



Sandstone
TOPTRIM8SAN

Top Trim Premium Colors

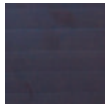

Black
TOPTRIM8BLK



Blue
TOPTRIM8BLU

All Colors Pieces Per Carton: 24
All Colors Length: 8'

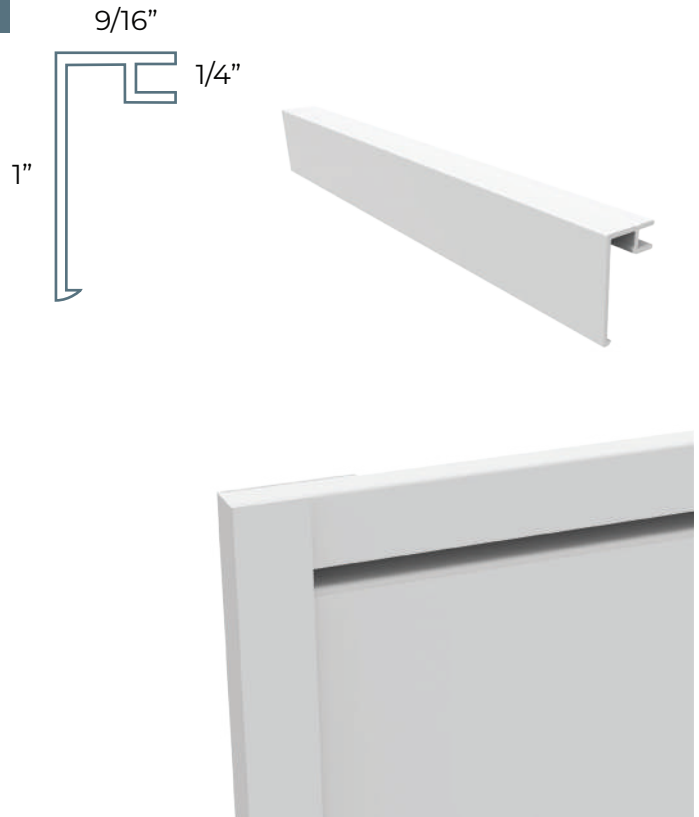

J-Trim

J-Trim is the most common trim used in the Panel system. Typically used for:

- The bottom of wall sections
- Around windows and doors
- Framing the edges of wall sections

J-Trim Standard Colors



Graphite
JTRIM8GRA



Dove Grey
JTRIM8DVG

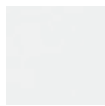

White
JTRIM8WHT



Sandstone
JTRIM8SAN

J-Trim Premium Colors

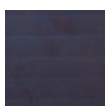

Black
JTRIM8BLK



Blue
JTRIM8BLU

All colors Pieces Per Carton: 24
All colors Length: 8'

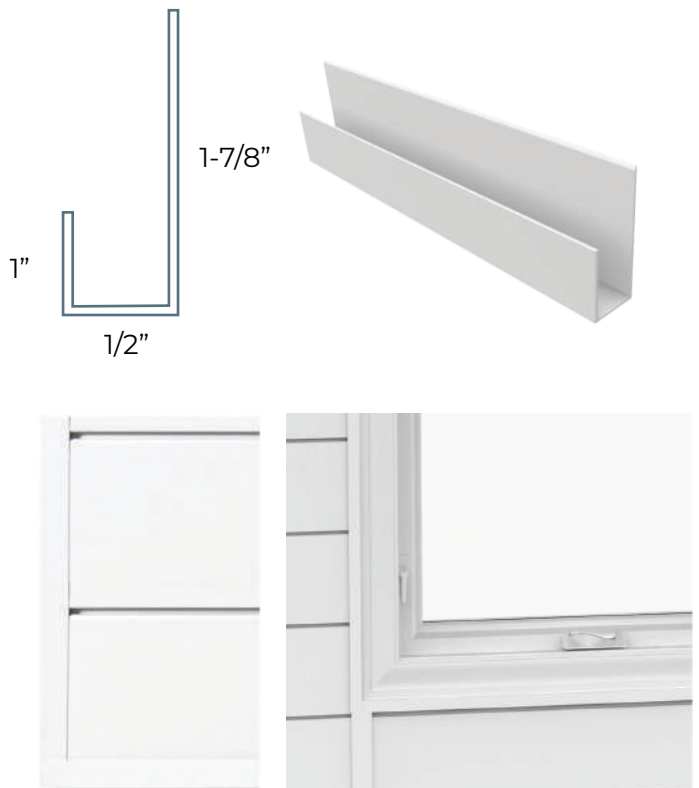



H-Trim

H-Trim is used to finish and connect two wall segments beside each other. Creating one continuous wall.

H-Trim Standard Colors

	Graphite HTRIM8GRA		Dove Grey HTRIM8DVG
	White HTRIM8WHT		Sandstone HTRIM8SAN

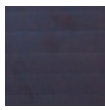
H-Trim Premium Colors

	Black HTRIM8BLK		Blue HTRIM8BLU
--	--------------------	---	-------------------



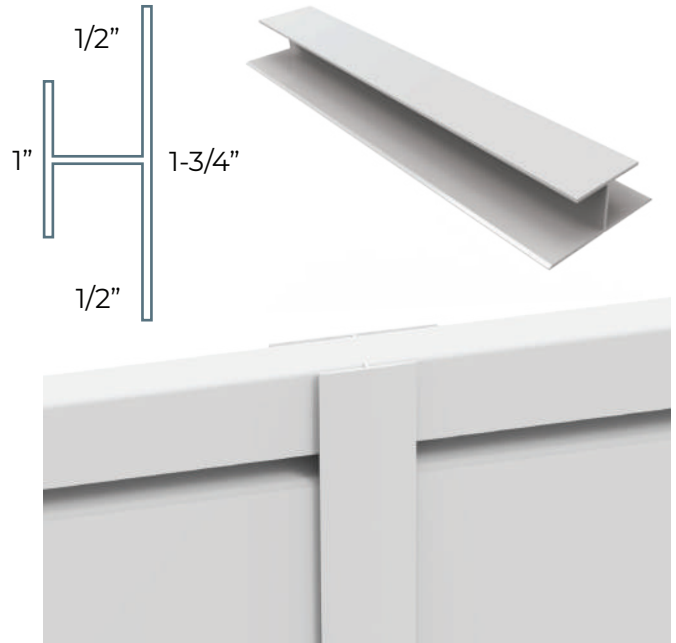

All Colors Pieces Per Carton: 24
All Colors Length: 8'



F-Trim

F-Trim is used to finish and connect both the inside and outside corners of wall segments that connect at 90 degrees.

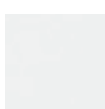
F-Trim Standard Colors

	Graphite FTRIM8GRA		Dove Grey FTRIM8DVG
	White FTRIM8WHT		Sandstone FTRIM8SAN

F-Trim Premium Colors

	Black FTRIM8BLK		Blue FTRIM8BLU
--	--------------------	---	-------------------

All colors Pieces Per Carton: 10
All colors Length: 8'

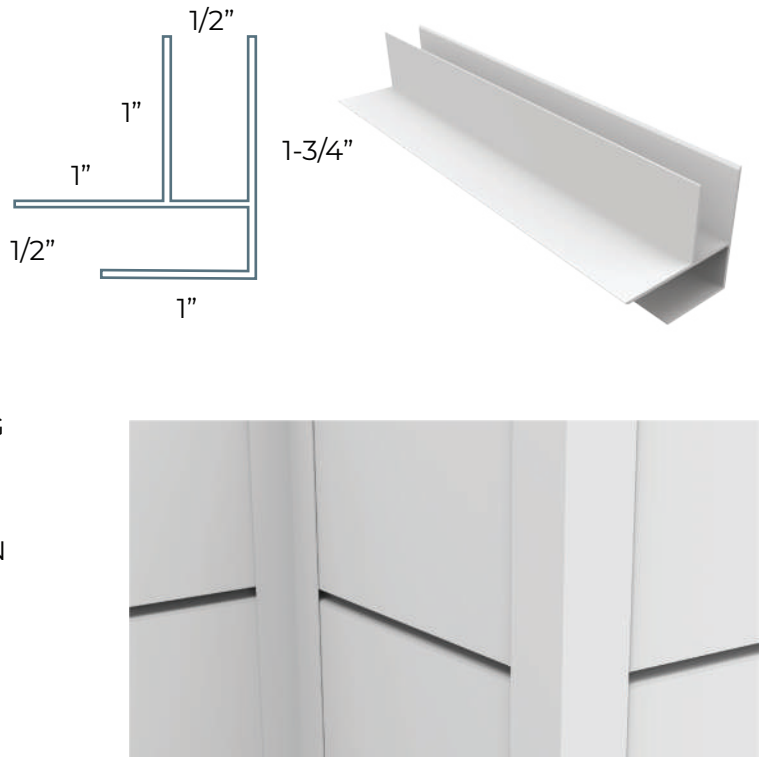



Accessories

Accessory Anatomy

CrownWall® offers a wide range of accessories, all made from high grade steel. Our back plates have been engineered to disperse the workload throughout the wall so you can hang whatever you want wherever you want.

These patented accessories are compatible with all CrownWall® panels.

Durable metal/powder coating

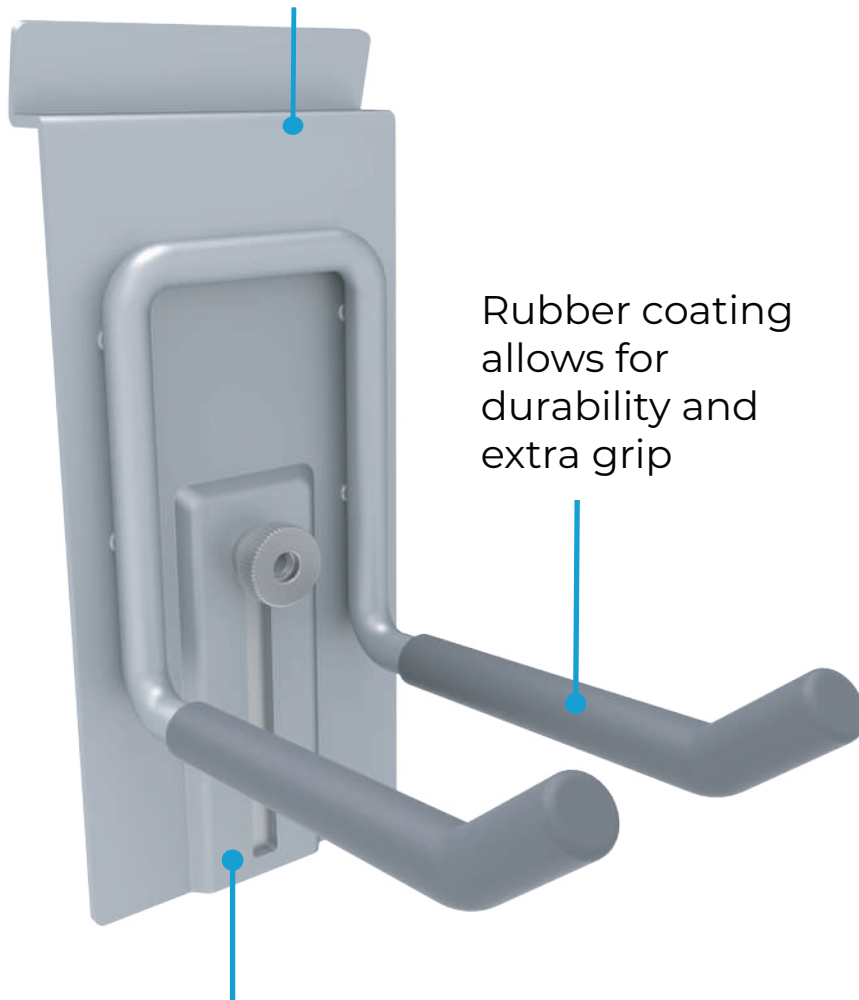

Locked into CrownWall®
6" panel



Locked into CrownWall®
PRO 8" panel



Locked into CrownWall®
Dual 3" panel

4" Single Hook (MHK4-V2)

The most universal hook! Versatile, yet robust. For use around the house or in retail stores. Hang tools, tape, bags, merchandise, cookware, pet supplies and much more!

Weight Capacity: 10 lbs / 5 kg

Dimensions: L 4.5" x W 1.25" x H 3.25"



Note: 4" single hook does not feature a rubber coating



4" Double Hook (DHK4-L)

An exceptionally versatile hook. Great for tools such as brooms, shovels, bicycle pumps, weed eaters or even drills and tool bags!

Weight Capacity: 55 lbs / 25 kg

Dimensions: L 4.5" x W 2.75" x H 6.25"



8" Double Hook (DHK8-L)

Ideal for those extra bulky items. The extra long 8" pegs provide ample space to hang power tools, shop vacs, snow shovels, and more.

Weight Capacity: 55 lbs / 25 kg
Dimensions: L 8" x W 2.75" x H 6.25"

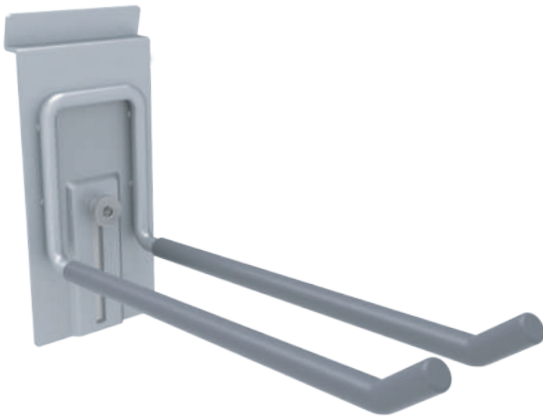

Small J Hook (JHKS-L)

Great for items requiring a bit more grasp. The curved ends give extra support, making slipping impossible. Hang larger tools such as brooms, shovels, bicycle pumps, weed eaters, bags, and large power tools.

Weight Capacity: 55 lbs / 25 kg
Dimensions: L 3.25" x W 2.75" x H 6.25"



Loop Hook (LHK-L)

Originally designed for holding garden hoses, ropes or extension cords. The large mouth, upturned end and rubber coating eliminates knots and tangling.

Weight Capacity: 55 lbs / 25 kg
Dimensions: L 8" x W 6.5" x H 6.25"



Bike Hook (BIKEHK-L)

Make the most of your walls! This hook brings a quick and convenient storage option for your bicycle by mounting the bike vertically from it's front wheel. Usable with most types of bicycles. This accessory is also an excellent solution for organizing other items such as golf bags.

Weight Capacity: 55 lbs / 25 kg
Dimensions: L 5.5" x W 2.75" x H 6.25"

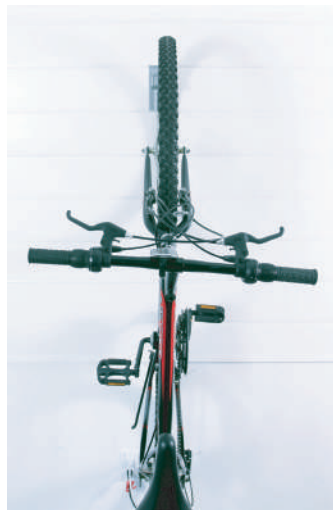

Bikes

Golf Bags

Fishing Rod Hooks (3 pack) (FISHHK3)

Uniquely designed to maintain upright position of fishing rods. Keep your fishing rods easily accessible and free of tangles, while the rubberized coating prevents scratches or damage. The two piece design ensures your equipment is secure. Accommodates up to 3 fishing rods.

Weight Capacity (per set): 55 lbs / 25 kg
Dimensions: Top Piece- D 3" x W 2.75" x H 4.5",
Bottom Piece- D 4" x W 2.75" x H 4.5"

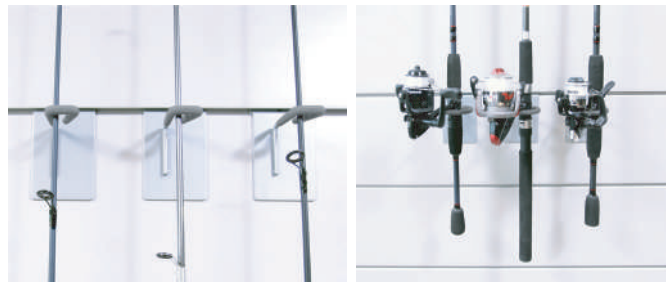
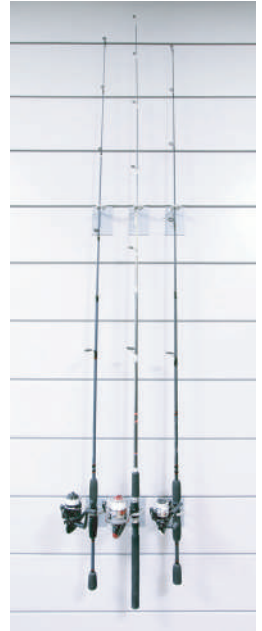

16" Magnetic Tool Bar (TOOLBAR16)

Save counter and drawer space with this versatile tool bar. The solid, flat steel frame and strong magnetic force latches on and holds anything that is magnetic. Your screwdrivers, pliers, scissors, ratchets and knives will be in reach at all times.

Weight Capacity: 5 lbs / 2.5 kg
Dimensions: L 1.25" x W 16.5" x H 6.25"

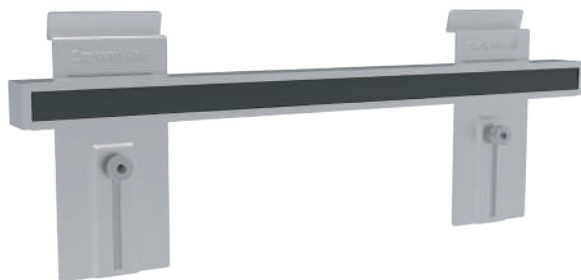

Medium Wire Basket 15" x 11" x 8" (WB1511-V2)

Lightweight and high capacity steel basket excellent for stashing away all types of things. For use in garages, sheds, basements, laundry rooms, closets and retail settings.

Weight Capacity: 55 lbs / 25 kg
 Dimensions: L 11" x W 15" x H 8"



Large Wire Basket 24" x 12" x 8" (WB2412-V2)

Super capacity steel basket offering a multitude of storage possibilities. This versatile basket can be used in a variety of settings including around the house and retail stores. Organize towels, clothes, cleaning supplies, motor oils, children's toys, etc.

Weight Capacity: 55 lbs / 25 kg
 Dimensions: L 12" x W 24" x H 8"



Paper Towel Rack (TOWELRK-V2)

The perfect all-in-one supply station. The practical shelf accommodates a range of items such as glass cleaner, bottles, and sprays. Mount a paper towel roll, shop towels or various tapes on the dowel below.

Weight Capacity: 20 lbs / 9 kg
 Dimensions: L 5" x W 16" x H 10"



Kayak Big J Hooks (1 Pair) (KAYAKHK-L)

Maintain the pristine condition of your kayak with these padded hooks. The modular hooks can be placed at any height or distance apart to adapt to different sizes and models of kayaks. Also great for storing other items in the garage, such as wood, flooring, or other spare building supplies. When not in use the hooks collapse neatly against the wall.

Weight Capacity (per set): 150 lbs / 68 kg
 Dimensions (one hook): L 21" x W 11.75" x H 6.25"



Coat Bracket (COATBR)

A must have for any mud room, closet, laundry room or work area. Ten pegs provide ample storage for any and all coats, jackets, uniforms or even hats or bags.

Weight Capacity: 20 lbs / 9 kg

Dimensions: L 3" x W 18" x H 5"

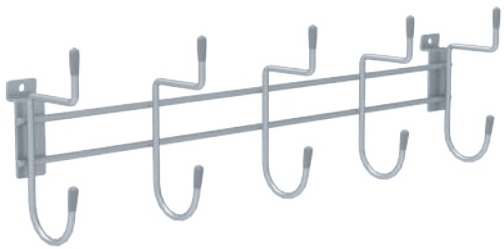

Folding Bike Hook (FBIKERK-L)

The ultimate space saver. Keep your bicycle off the floor and easily accessible, no awkward reaching! When not in use the hook collapses neatly against the wall. The bicycle must have a horizontal beam in order to be used with this rack.

Weight Capacity: 55 lbs / 25 kg

Dimensions: L 10.25" x W 10.25" x H 6.25"



Solid Metal Shelf 24" x 12" (MS2412)

This solid metal shelf is perfect for organizing different sized or awkward items. While providing a stylish look in any part of your home!

Weight Capacity: 55 lbs / 25 kg
Dimensions: L 12" x W 24" x H 5"



Solid Metal Shelf 48" x 12" (MS4812)

This larger format of solid metal shelf is great for organizing larger items up to 48". While being stylish enough to be used in any part of the home!

Weight Capacity: 75 lbs / 34 kg
Dimensions: L 12" x W 48" x H 5"

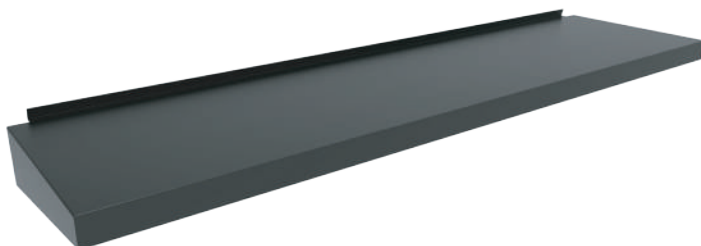

Wire Shelf with Rail 24" x 12" (WSBKT2412-V2)

Lightweight and robust, this shelf is constructed with support arms for extra stability. An integrated rail provides the perfect place to hang clothing. Use in closets, laundry rooms, garages and more.

Weight Capacity: 55 lbs / 25 kg
Dimensions: L 12" x W 24" x H 5"

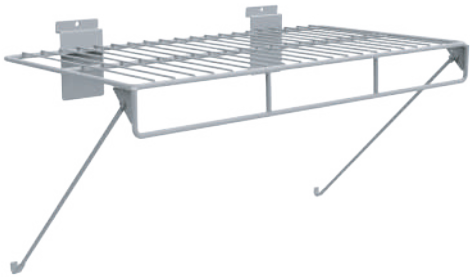

Wire Shelf with Rail 48" x 12" (WSBKT4812-V2)

Our largest shelf. Lightweight and robust, this shelf is constructed with support arms for extra stability. An integrated rail provides the perfect place to hang clothing. Use in closets, laundry rooms, garages and more.

Weight Capacity: 150 lbs / 68 kg
Dimensions: L 12" x W 48" x H 5"

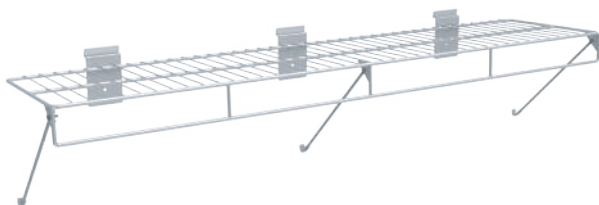

Shoe Rack 30" x 13.5" (WSSHOE)

A 30 degree angled slope prominently displays stored goods like helmets, hats, books and shoes. The vented design allows drip drying of wet or muddy footwear for ultimate shoe storage. This shelf can fit up to 3 pairs of shoes or boots securely with the integrated 2.5" lip.

Weight Capacity: 55 lbs / 25 kg
Dimensions: L 13.5" x W 20" x H 9"



Sold individually

Mesh Basket 17" x 30" x 19" (BALLBAG)

A stylish way to contain balls, children's toys and more otherwise annoying items.

Weight Capacity: 40 lbs / 18 kg
Dimensions: L 17" x W 30" x H 19"



Wire Shelf with Bracket 24" x 12" (WS2412-V2)

Solid brackets provide this practical wire shelf extra stability, while the open design eliminates any need for dusting. Storage ideas include paint tins, gas cans, cleaning supplies, car products and the like.

Weight Capacity: 55 lbs / 25 kg
Dimensions: L 12" x W 24" x H 5"

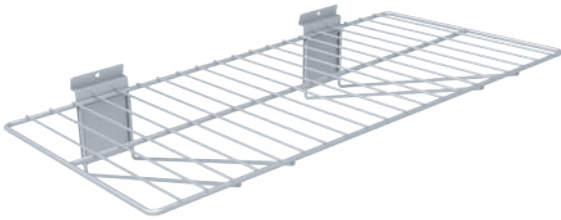

Metal Bin Hooks (1 pair) (BINHK)

Low profile and specially devised to clip onto recycling bins and other plastic totes with a lip. Other uses include hanging bags or small items. Sold as a pair.

Weight Capacity (per pair): 50 lbs / 23 kg
Dimensions (one hook): L 1" x W 1" x H 3"



14" Shelf Bracket (1 Pair) (SHELFBRKT)

This versatile shelf bracket is designed to accommodate any suitable shelf planks up to 14" in depth. Shelves can be placed on the bracket, with the option of fastening the shelf to the bracket from the bottom*. Sold in a set of two brackets.

Weight Capacity (per hook. True weight capacity depends on the material and type of plank used to make a shelf): 55 lbs / 25 kg

Dimensions: L 14.75" x W 2.75" x H 7"

**Shelving planks and any shelf fastening hardware not included. Shelf fastening screws should be of suitable length and not penetrate the shelf plank.*

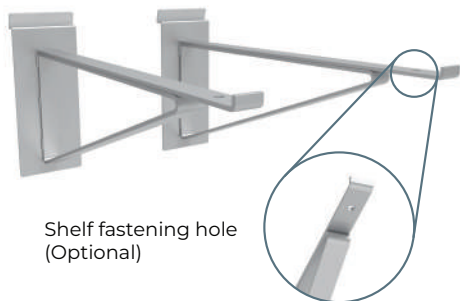

Tire Hook (4 Pack) (TIRE4HK)

The ideal solution for storing your seasonal tires, rims, or even to display your wheels. This set of 4 tire hooks features a collapsible hook that allows for ease of shipping.

Per Hook

Weight Capacity: 65 lbs / 29 kg

Dimensions: L 14.5" x W 11.75" x H 6.25"

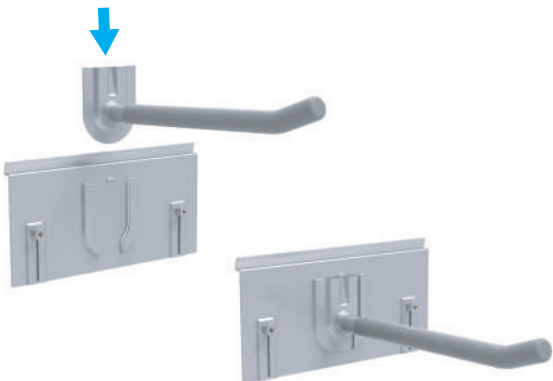

Small Plastic Bin (CWBS)

Provides an easy to access option for those little things that tend to wonder off. Keep track of your screws, nails, nuts, bolts, and other small supplies.

Weight Capacity: 33 lbs / 15 kg
Dimensions: L 5" x W 5.5" x H 3.5"



Medium Plastic Bin (CWBM)

Handy for storing a variety of small to medium size items such as spray cans, cleaners, caulking, loose cables, gardening or craft supplies.

Weight Capacity: 66 lbs / 30 kg
Dimensions: L 5" x W 6.5" x H 7"

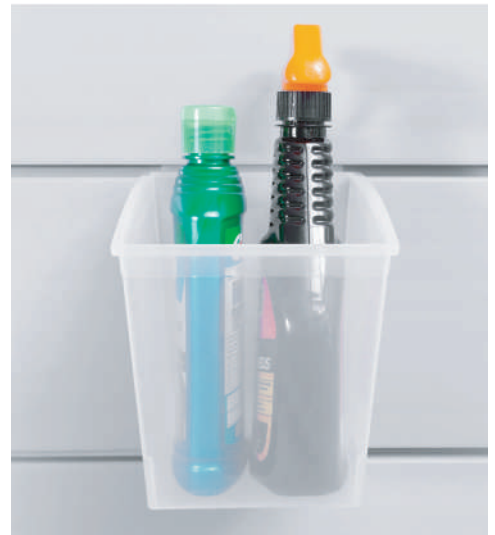

Large Plastic Bin (CWBL)

A versatile storage bin able to accommodate a wide range of items. The unique size makes it the perfect "catch all" bin.

Weight Capacity: 66 lbs / 30 kg
Dimensions: L 10" x W 13" x H 6.5"



Small Utility Bin

The ideal bin for organizing small items such as nuts, bolts, washers, and small parts.

Weight Capacity: 33 lbs / 15 kg
 Dimensions: L 4.53" x W 5.51" x H 3.35"



Available dividers (Small)

Color Options



Red
 CWUBS-RED



Blue
 CWUBS-BLU

Medium Utility Bin

Handy for storing a variety of small to medium size items such as spray cans, cleaners, caulking, and loose cables.

Weight Capacity: 66 lbs / 30 kg
 Dimensions: L 5.91" x W 5.91" x H 7"



Color Options



Red
 CWUBM-RED



Blue
 CWUBM-BLU

Wide Utility Bin

A versatile storage bin able to accommodate a wide range of items. The unique size makes it the perfect "catch all" bin. Handy dividers can be used to create 2 compartments or three.

Weight Capacity: 66 lbs / 30 kg
 Dimensions: L 4.53" x W 11.42" x H 3.35"



Available dividers (Small)

Color Options



Red
 CWUBW-RED



Blue
 CWUBW-BLU

Large Utility Bin

A large storage bin ideal for storing large parts, supplies, or equipment.

Weight Capacity: 66 lbs / 30 kg
 Dimensions: L 10.83" x W 10.83" x H 6.69"

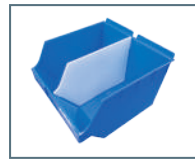

Available dividers (Large)

Color Options



Red
 CWUBW-RED



Blue
 CWUBW-BLU

Small Divider (DIVS)

Compatible with the Small and the Wide utility bins

Dimensions: L 3.93" x W 0.078" x H 3.15"



Small Utility Bin



Wide Utility Bin

Large Divider (DIVL)

Compatible with the Large utility bins

Dimensions: L 10.23" x W 0.157" x H 6.5"



Large Utility Bin

Color Options

Utility bins are available in two colors:



Red



Blue



Bins shown on a CrownWall® 8' x 4' slatwall panel kit.





Accessory Kits

10 Piece Hook Kit (CW10-K)

An excellent assortment of hooks to help get you started. High grade steel back plates disperse the workload throughout the wall. Empowering you to hang whatever you want, wherever you want.



Panel kit and Items on accessories not included

Included in the Kit



6 x 4" Single Hook

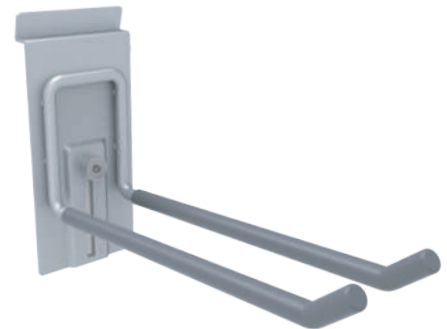

1 x 8" Double Hook



1 x Bike Hook



1 x 4" Double Hook



1 x Small J Hook

20 Piece Hook Kit (CW20-K)

Must have kit comprised of a wide selection of our most versatile hooks. High grade steel back plates disperse the workload throughout the wall. Hang whatever you want, wherever you want.

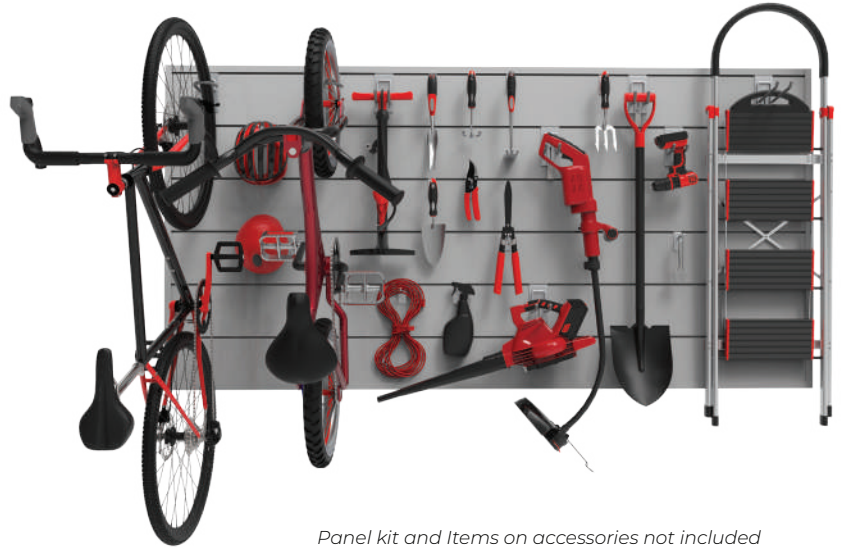

Panel kit and Items on accessories not included

Included in the Kit

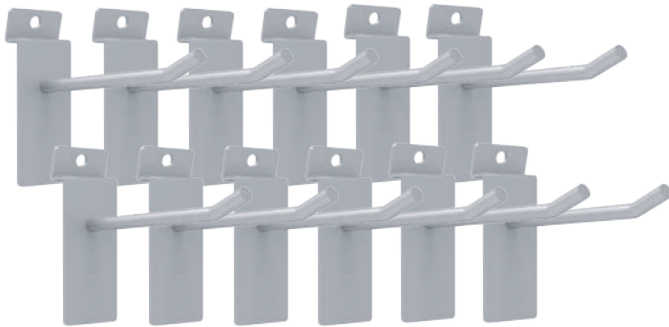

12 x 4" Single Hook

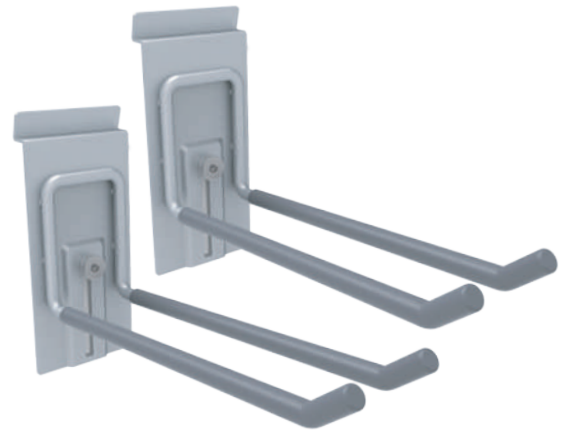

2 x 8" Double Hook



2 x Bike Hook



2 x 4" Double Hook



2 x Small J Hook

5 Piece Shelf and Basket Kit (CW5SB-K)

Wire shelf and basket value pack for all your difficult to hang items. Lightweight and high capacity steel with a sleek powder-coated finish. An exceptional choice for giving your closet, laundry room or garage a face lift.

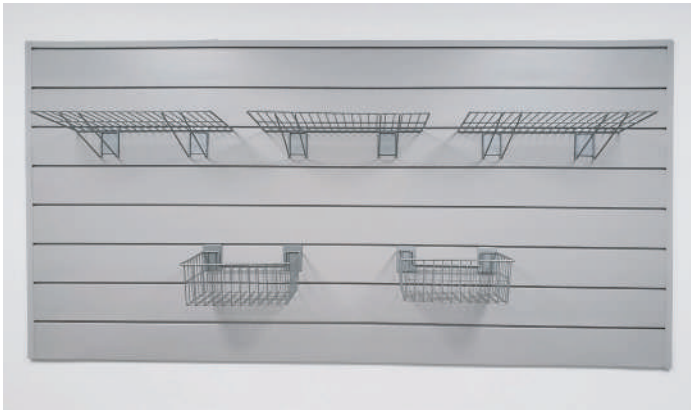

Panel kit and Items on accessories not included

Included in the Kit



3 x Wire Bracket Shelf 24" X 12"

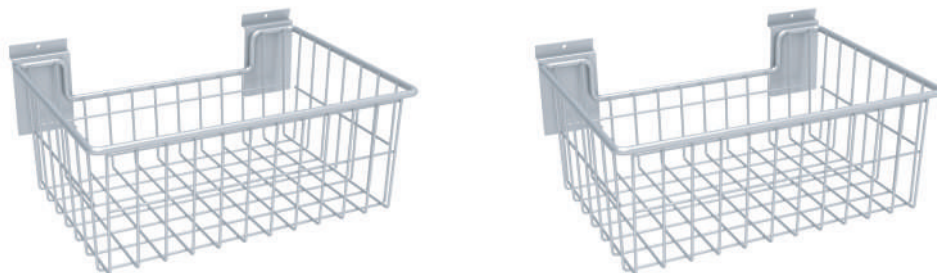

2 x Medium Wire Basket 15" x 11" x 8"

16 Piece Sports Kit (CW16SPRT-K)

A game changing kit for any outdoorsy type. The fishing rod hooks keep your fishing rods easily accessible and free of tangles. Vertically hang up to two bicycles with the included bike hooks. The small J hooks and 4-inch double hooks make quick work of camping gear or any other athletic equipment. Finally, the 4-inch hooks take care of any left over items.



Panels and Items on accessories not included

Included in the Kit



2 x 4" Double Hook



2 x Small J Hook



**1 x Fishing Rod Holder
(3 Pack)**



2 x Bike Hook

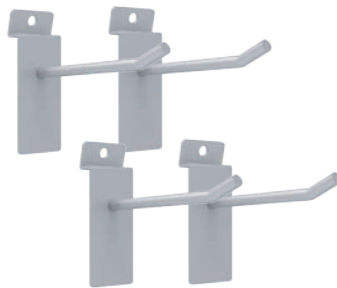

4 x 4" Single Hook

10 Piece Organizing Kit (CW10ORG2-K)

The handy man's dream. This combination of accessories has been devised for all-encompassing accessibility. The shelf and paper towel holder accommodates a range of cleaning products, oil jugs and sprays, while the lower dowel handles paper towels, shop towels or various tapes. Your frequently used tools are always ready to go thanks to the magnetic tool holder. The small plastic bins keep your fasteners or other small items in check. Finally, the 4-inch hooks take care of anything left over.



Panels and Items on accessories not included

Included in the Kit

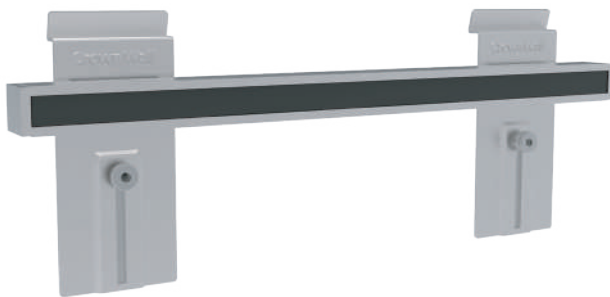

1 x 16" Magnetic Tool Bar

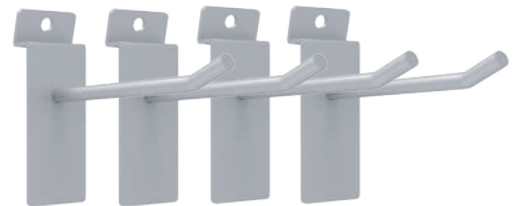

4 x 4" Single Hook

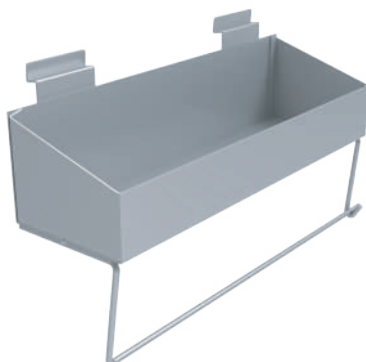

1 x Paper Towel Rack



4 x Small Plastic Bin

12 Piece Plastic Bin Kit (CW12BIN-K)

Our storage bin sampler pack, offering a multitude of storage possibilities. Solid bottoms mean any mess is contained inside the bin, which is easily cleaned.



Panels and Items on accessories not included

Included in the Kit



10 x Small Plastic Bin



2 x Large Plastic Bin



Overhead Storage

4' x 8' Overhead Storage Rack

The perfect way to further maximize the space in your garage. The 4' x 8' Overhead Storage Rack from CrownWall® is easy to install and can hold up to 600 lbs! This 4' x 8' unit can be installed on its own, or in a series of multiple units to accommodate any size of garage.

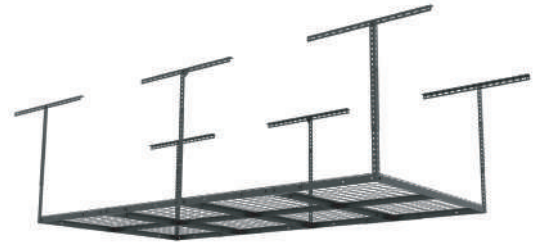

The 4' x 8' Overhead Storage Rack is constructed of steel, and comes in a durable black powder coated finish.

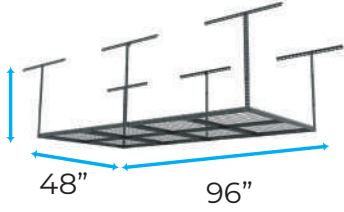
Product Image	Product Name	Product Code	Weight Capacity	Product Dimensions
	4'x8' Overhead Storage Rack	CW-OR48	600 lbs (272 kg) evenly distributed	22" - 44" (Adjustable) 

Accessories

All accessories are constructed of steel, and come in a durable black powder coated finish (accessories are only compatible with the CW-OR48 overhead storage rack).



Interior Hook

Mounted to the underside of the 4' x 8' storage rack, this hook is ideal for hanging a variety of items, such as bikes, bags, and large tools.

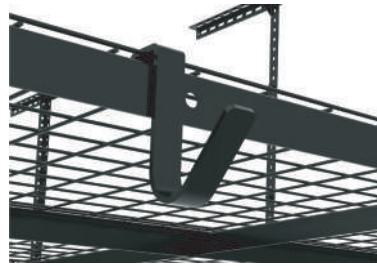





Exterior Hook

Mounted to the outside of the frame, this general purpose hook can conveniently hold any item that needs to be within reach.

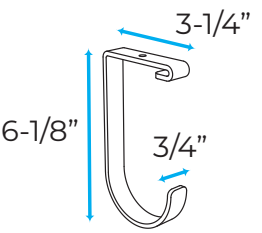

Large Side Hook

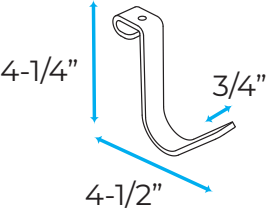
Ideal for holding larger items such as ladders, building supplies, or large tools. The large side hook securely bolts onto the side of either one of the support legs.

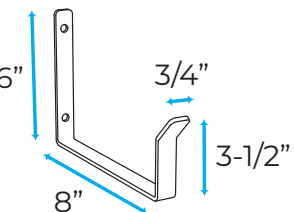
Product Image	Product Name	Product Code	Weight Capacity	Carton Qty. (sets)	Product Dims. (per hook)
	Interior Hook (4 Pack)	CW-OR-INTHK	50 lbs (23 kg) per hook	20	
	Exterior Hook (4 Pack)	CW-OR-EXTHK	50 lbs (23 kg) per hook	30	
	Large Side Hook (2 Pack)	CW-OR-SIDEHKL	35 lbs (16 kg) per hook	30	

2' x 4' Wall Rack



The CrownWall® Wall Rack is the perfect solution for maximizing storage by mounting to the wall.

When properly anchored to a wall, this unit is capable of a 600 lbs weight capacity!

Multiple units can be connected together as well to create continuous storage.

The CrownWall® Wall Rack is constructed of steel, and comes in a durable black powder coated finish.

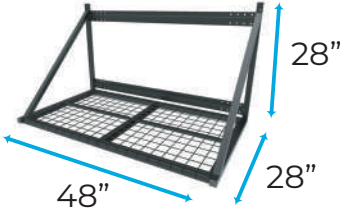
Product Image	Product Name	Product Code	Weight Capacity	Product Dimensions
	Wall Rack	CW-WALLRK	600 lbs (272 kg) evenly distributed	

Inverted Configuration

Easily install the unit in the inverted position allowing for more space below the unit for storage. Use the supplied hooks for hanging various items.



Tire Storage Configuration

By simply removing the mesh decks, you can easily use the unit for tire and rim storage.



Included Accessories

Each Unit will come with a set of hooks, a 12" hook and a 6" hook, three pieces of each. Ideal for hanging bikes, golf bags, ladders, and more!

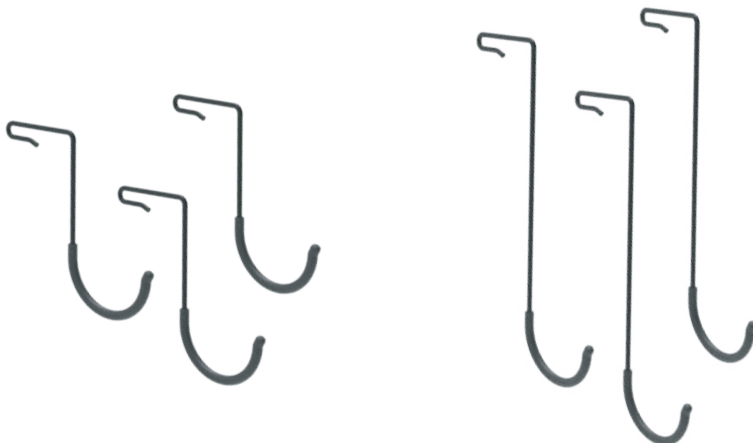



PRO Series Cabinets



Quality, Durability and Great Value

The CrownWall[®] PRO Series Cabinets are the perfect solution for storing and organizing your things in your garage, basement, or any other part of your home. Sold individually, or in a variety of configurations.

Key Features



Strong and Durable



Soft Glide Drawers

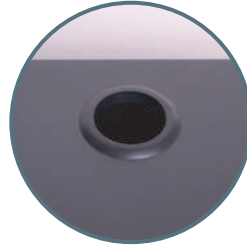

Cable Access Hole
(Except with 5 Drawer Cabinet)



Soft-Close Door Hinges



Removable Kick Plates



Adjustable Feet



Secure Locking Mechanisms

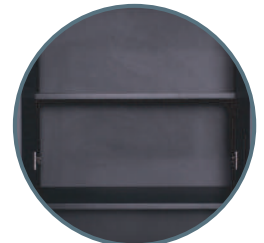

Adjustable Shelving



PRO Series Cabinet Handles

Solid painted handles are full length and ergonomic. Offered in four distinct colors:



Silver

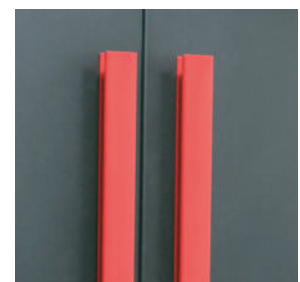

Red

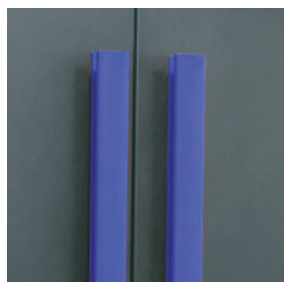

Blue

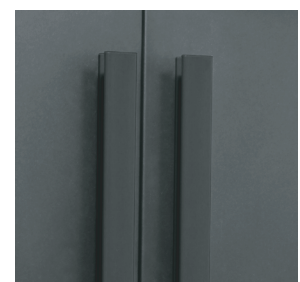

Black

2 Door Wall Cabinet (CW-PRO-WALL)

24" W x 14" D x 20" H

- Total Weight Capacity: 100 lbs. (50 lbs. per shelf)
- Welded steel frame and doors
- Double walled doors
- Soft close door hinges
- Includes 1 adjustable shelf
- Full cabinet locking-mechanism
- Designed to be screwed to a wall to ensure safety
- Durable black powder-coat finish
- Assembled for quick and easy installation
- Alignment holes on cabinet side walls facilitate assembly of two or more units



Handle Color Options

Silver (CW-PRO-WALL-SLV) Blue (CW-PRO-WALL-BLU)
Red (CW-PRO-WALL-RED) Black (CW-PRO-WALL-BLK)

2 Door Base Cabinet (CW-PRO-2DR)

24" W x 21.75" D x 34.75" H

- Total Weight Capacity: 300 lbs. (100 lbs. on the top and 100 lbs. per shelf)
- Welded steel frame and doors
- Double walled doors
- Soft close door hinges
- Includes 1 steel adjustable shelf
- Full cabinet locking-mechanism
- Designed to be screwed to a wall to ensure safety
- Durable black powder-coat finish
- Assembled for quick and easy installation
- Alignment holes on cabinet side walls facilitate assembly of two or more units



Handle Color Options

Silver (CW-PRO-2DR-SLV) Blue (CW-PRO-2DR-BLU)
Red (CW-PRO-2DR-RED) Black (CW-PRO-2DR-BLK)

2 Door Tall Cabinet (CW-PRO-TALL)

32" W x 24" D x 80" H

- Total Weight Capacity: 600 lbs. (100 lbs. on the top and 100 lbs. per shelf)
- Welded steel frame and doors
- Double walled doors
- Soft close door hinges
- Includes 4 steel adjustable shelves
- Full cabinet locking-mechanism
- Designed to be screwed to a wall to ensure safety
- Durable black powder-coat finish
- Assembled for quick and easy installation
- Alignment holes on cabinet side walls facilitate assembly of two or more units



Handle Color Options

Silver (CW-PRO-TALL-SLV) Blue (CW-PRO-TALL-BLU)
Red (CW-PRO-TALL-RED) Black (CW-PRO-TALL-BLK)

5 Drawer Base Cabinet (CW-PRO-5DWR)

24" W x 21.75" D x 34.75" H

- Total Weight Capacity: 600 lbs. (100 lbs. on the top and 100 lbs. per drawer)
- Welded steel frame and drawers
- Includes 5 full-extension ball bearing soft-close drawers with mat liners
- Full cabinet locking-mechanism
- Designed to be screwed to a wall to ensure safety
- Durable black powder-coat finish
- Assembled for quick and easy installation
- Alignment holes on cabinet side walls facilitate assembly of two or more units



Handle Color Options

Silver (CW-PRO-5DWR-SLV) Blue (CW-PRO-5DWR-BLU)
Red (CW-PRO-5DWR-RED) Black (CW-PRO-5DWR-BLK)

Countertops

Durable stainless steel countertops are sold in three sizes to work with any PRO Series cabinet configuration.

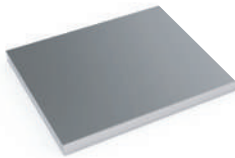

24" Stainless Steel Countertop
(CW-24WSSS)

Dimensions: 24" x 22"



48" Stainless Steel countertop
(CW-48WSSS)

Dimensions: 48" x 22"



72" Stainless Steel Countertop
(CW-72WSSS)

Dimensions: 72" x 22"

Backsplashes

Versatile aluminum backslashes are sold in two sizes, working with various PRO Series cabinet configuration. All trims and panels included.



48" Aluminum Backsplash (CW-PRO-B48)

Dimensions: 48" x 23.75"



72" Aluminum Backsplash (CW-PRO-B72)

Dimensions: 72" x 23.75"

Common Configurations

All cabinets in the PRO series selection are sold individually. Here are some common configurations that can be achieved using the 24", 48" or 72" stainless steel work surfaces.

3 Piece Work Station (24")



- 1 x Wall Cabinet
- 1 x 2 Door Base Cabinet
- 1 x 24" Countertop

5 Piece Work Station (48")



- 2 x Wall Cabinet
- 1 x 2 Door Base Cabinet
- 1 x 5 Drawer Base Cabinet
- 1 x 48" Countertop

6 Piece Work Station (72")



- 3 x Wall Cabinet
- 2 x 2 Door Base Cabinet
- 1 x 72" Countertop

4 Piece Work Surface (72")



- 3 x 2 Door Base Cabinet
- 1 x 72" Countertop

4 Piece tool Set (56")



- 1 x Wall Cabinet
- 1 x Tall Cabinet
- 1 x 5 Drawer Base Cabinet
- 1 x 24" Countertop

4 Piece Cabinet Set (56")



- 1 x Wall Cabinet
- 1 x Tall Cabinet
- 1 x 2 Door Base Cabinet
- 1 x 24" Countertop

Common Configurations

7 Piece Full Configuration (112")

- 2 x Upper Cabinet
- 2 x Tall Cabinet
- 1 x 2 Door Base Cabinet
- 1 x 5 Drawer Base Cabinet
- 1 x 48" Countertop

9 Piece Full Configuration (136")

- 3 x Wall Cabinet
- 2 x Tall Cabinet
- 2 x 2 Door Base Cabinet
- 1 x 5 Drawer Base Cabinet
- 1 x 72" Countertop

8 Piece Work Station (136")

- 3 x Wall Cabinet
- 2 x Tall Cabinet
- 1 x 2 Door Base Cabinet
- 1 x 5 Drawer Base Cabinet
- 1 x 72" Countertop

10 Piece Work Station (200")

- 3 x Wall Cabinet
- 4 x Tall Cabinet
- 1 x 2 Door Base Cabinet
- 1 x 5 Drawer Base Cabinet
- 1 x 72" Countertop

Modular System allows for Endless Combinations!





Carrera GT

TM

ZOOMflor **Flooring**

The ZOOMflor™ tile system is a floating interlocking floor system, the 12" x 12" tiles are quick and easy to install. Holds 12,000 lbs per sq. ft.

Individual tiles are snapped together to form a continuous surface that is durable and comfortable.

Great for the garage, workshop, basement, cold cellar, playroom, laundry room, trade show flooring, and more!

Design your own floor today by going to zoomflor.com

- ✓ Anti-slip
- ✓ High-Impact Polymer, High-Impact Polypropylene
- ✓ Do it Yourself
- ✓ Quick and easy installation
- ✓ Easy to clean and maintain
- ✓ Resistant to oil, grease, and salt
- ✓ UV stabilized, high impact, and fade resistant
- ✓ Free-flowing underside allows water and moisture to escape
- ✓ Recyclable
- ✓ Made in North America
- ✓ 15 Year Warranty

Complete tile system includes floor tiles, and edges

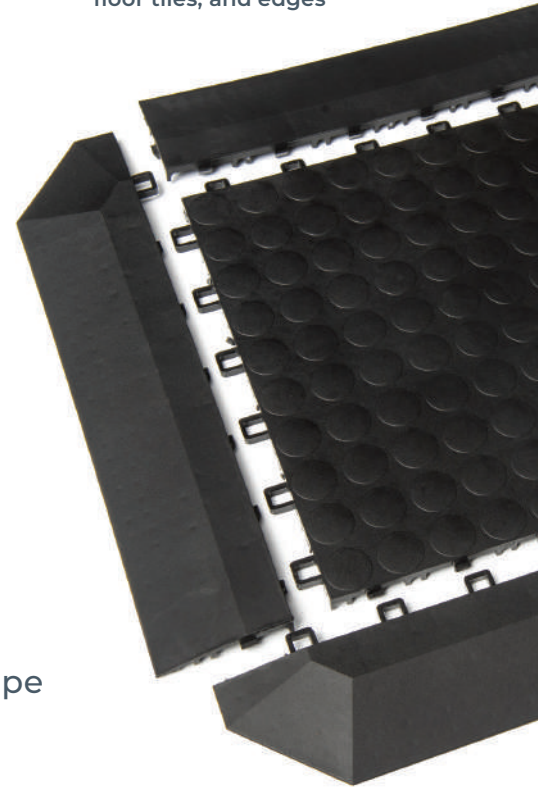

Tile Pattern Options

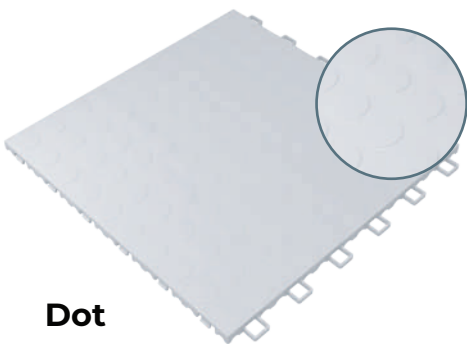

Dot

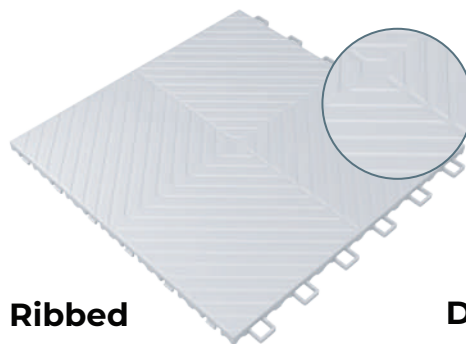

Ribbed

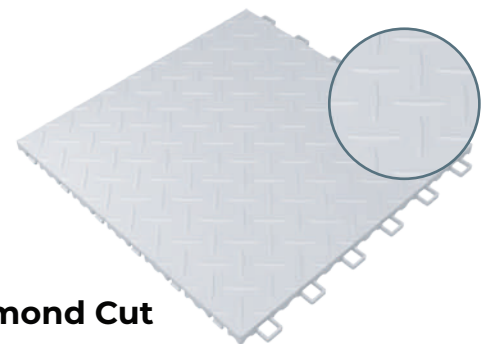

Diamond Cut

Color Options



Black

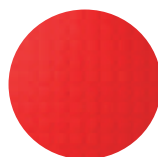

Red

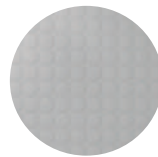

Silver



White

Modular Flooring

ZOOMflor™ tile system is a floating interlocking floor system - great for garages, basements, decks and balconies. Installation of the 12" x 12" tiles is quick and easy.

Individual tiles are snapped together to form a continuous surface that is durable and comfortable.

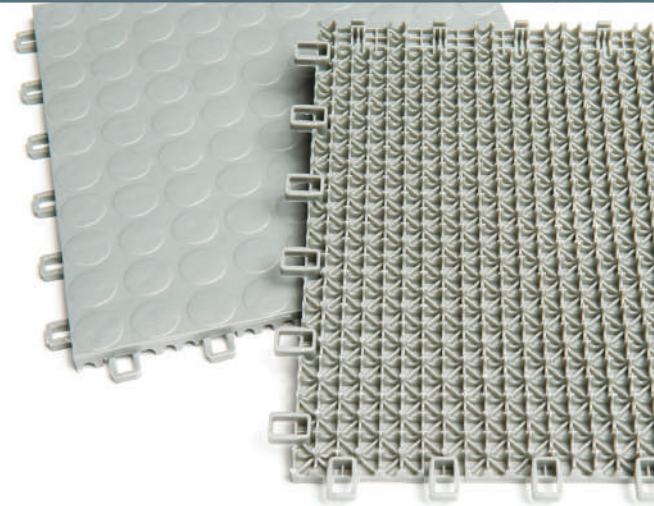

ZOOMflor™ Tiles

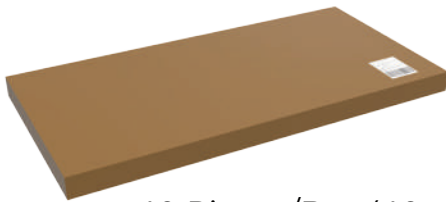

40 Pieces/Box (40 sq. ft.)

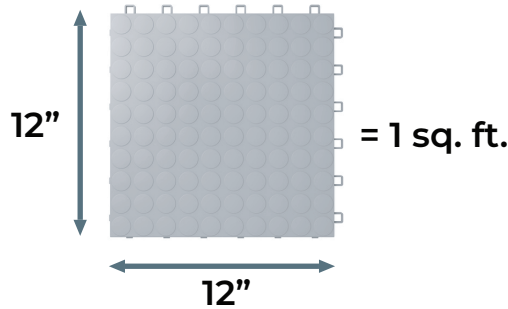

Available Colors

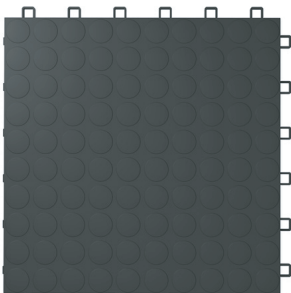

Black
ZF12DOT-BLK-C

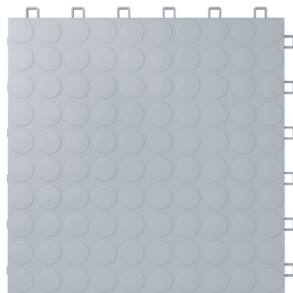

Silver
ZF12DOT-SLV-C



White
ZF12DOT-WHT-C

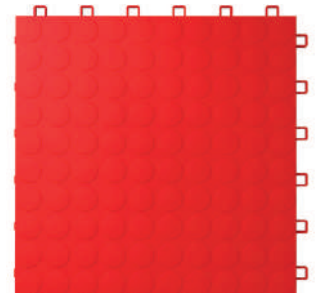

Red
ZF12DOT-RED-C

ZOOMflor™ Ramp Edges

The ZOOMflor™ edge ramp is used to finish off the floor, at the front of the garage. A total of four ramps are available for finishing all 4 sides of the floor.

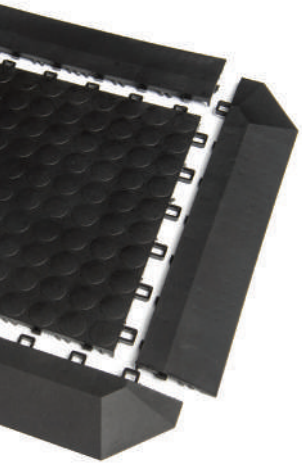

Corner ramp with hook



Edge ramp with hook



Corner ramp with peg



Edge ramp with peg

Edge Box Quantities



50 Pieces/box

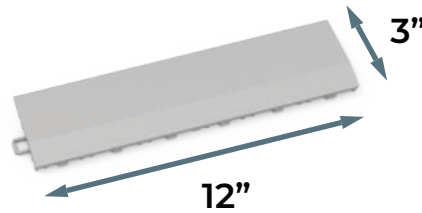

Corner Box Quantities



25 Pieces/box

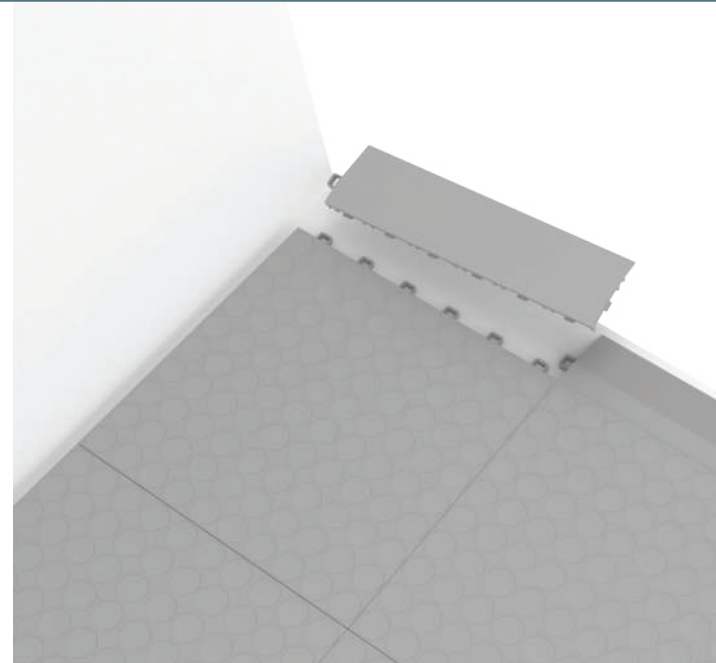
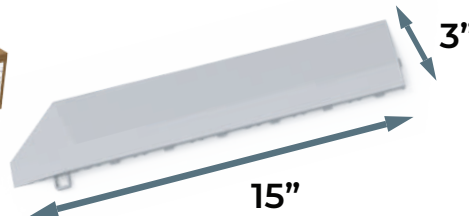

Available Colors For All Styles Of Ramps



Black
ZF12REP-BLK-C



Silver
ZF12REP-SLV-C



White
ZF12REP-WHT-C



Red
ZF12REP-RED-C

ZOOMflor™ Common Configurations

One Car Garage

Covers an area of 200 sq. ft. or a garage that is around 10' x 20'.

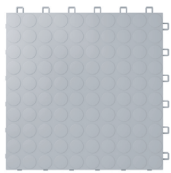

200 x ZOOMflor™
12" x 12" Tiles
(**5 x** ZOOMflor™ Tile
Boxes (40 pieces/box))



10 x ZOOMflor™
12" Edges
with Pegs

Two Car Garage

Covers an area of 320 sq. ft. or a garage that is around 16' x 20'.

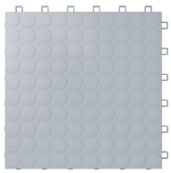

320 x ZOOMflor™
12" x 12" Tiles
(**8 x** ZOOMflor Tile
Boxes (40 pieces/box))



16 x ZOOMflor™
12" Edges
with Pegs

Three Car Garage

Covers an area of 600 sq. ft. or a Garage that is around 30' x 20'.

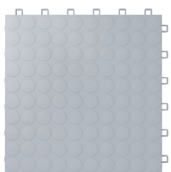

600 x ZOOMflor™
12" x 12" Tiles
(**15 x** ZOOMflor Tile
Boxes (40 pieces/box))



30 x ZOOMflor™
12" Edges
with Pegs



**Organize and beautify any part of your home with
CrownWall® Products**





 (647) 556-3664

 info@highburydoors.ca